



Genomic DNA from tissue

User manual

NucleoSpin® 96 Tissue

NucleoSpin® 96 Tissue Core Kit

February 2012/Rev.06

Table of contents

1	Components	4
1.1	Kit contents	4
1.2	Reagents to be supplied by user	5
2	Product description	6
2.1	The basic principle	6
2.2	Kit specifications	6
2.3	Required hardware	7
2.4	Accessories supplied for use of the NucleoSpin® 96 Tissue Core Kit	8
2.5	Automated processing on robotic platforms	10
2.6	Elution procedures	10
3	Storage conditions and preparation of working solutions	12
4	Safety instructions – risk and safety phrases	14
4.1	Risk and safety phrases	14
4.2	GHS classification	15
5	Protocols	17
5.1	NucleoSpin® 96 Tissue – centrifuge processing	17
5.2	NucleoSpin® 96 Tissue – vacuum processing	22
6	Appendix	29
6.1	Troubleshooting	29
6.2	Ordering information	31
6.3	Product use restriction/warranty	32

1 Components

1.1 Kit contents

REF	NucleoSpin® 96 Tissue		
	2 x 96 preps 740741.2	4 x 96 preps 740741.4	24 x 96 preps 740741.24 ¹
Lysis Buffer T1	50 mL	100 mL	6 x 100 mL
Binding Buffer BQ1	50 mL	100 mL	6 x 100 mL
Wash Buffer B5 (Concentrate) ²	100 mL	2 x 100 mL	12 x 100 mL
Wash Buffer BW	125 mL	2 x 125 mL	12 x 125 mL
Elution Buffer BE ³	50 mL	100 mL	6 x 100 mL
Proteinase K (lyophilized) ²	2 x 75 mg	4 x 75 mg	24 x 75 mg
Proteinase Buffer PB	8 mL	15 mL	6 x 15 mL
NucleoSpin® Tissue Binding Plates (green rings)	2	4	24
Round-well Blocks ⁴	2	4	24
MN Square-well Blocks	2	4	24
MN Wash Plates ⁵	2	4	24
Rack of Tube Strips ⁶	2	4	24
Cap Strips	24	48	288
Self-adhering PE Foil	5	10	60
User manual	1	1	6

¹ The kit for 24 x 96 preparations (REF 740741.24) consists of 6 x REF 740741.4.

² For preparation of working solutions and storage conditions, see section 3.

³ Elution Buffer BE: 5 mM Tris/HCl, pH 8.5

⁴ Including 12 Cap Strips for each block

⁵ For use with vacuum only

⁶ Sets of 1 rack, 12 strips with 8 tubes each, including Cap Strips

1.1 Kit contents *continued*

NucleoSpin® 96 Tissue Core Kit	
REF	4 x 96 preps 740454.4
Lysis Buffer T1	100 mL
Binding Buffer BQ1	100 mL
Wash Buffer B5 (Concentrate) ¹	2 x 100 mL
Wash Buffer BW	2 x 125 mL
Elution Buffer BE ²	100 mL
Proteinase K (lyophilized) ¹	4 x 75 mg
Proteinase Buffer PB	15 mL
NucleoSpin® Tissue Binding Plates (green rings)	4
User manual	1

1.2 Reagents to be supplied by user

- 96–100% ethanol (for preparation of working solutions; see section 3)

For more detailed information regarding special hardware required for centrifuge or vacuum processing, please see section 2.3.

For recommended accessories for use of the flexible **NucleoSpin® 96 Tissue Core Kit** (reduced kit composition; REF 740454.4), please see section 2.4.

¹ For preparation of working solutions and storage conditions see section 3.

² Elution Buffer BE: 5 mM Tris/HCl, pH 8.5

2 Product description

2.1 The basic principle

The **NucleoSpin® 96 Tissue** kit is designed for the efficient isolation of high molecular weight genomic DNA from tissue samples or cells. With the **NucleoSpin® 96 Tissue** procedure, sample lysis is achieved by incubation of the samples in a solution containing SDS and Proteinase K. Appropriate conditions for binding of DNA to the silica membrane in the NucleoSpin® Tissue Binding Plate are created by addition of large amounts of chaotropic salt and ethanol to the lysate. The binding process is reversible and specific to nucleic acids. While DNA is kept on the silica membrane, contaminations are removed by washing with two different wash buffers. Pure genomic DNA is finally eluted under low ionic strength conditions in a slightly alkaline elution buffer.

2.2 Kit specifications

- **NucleoSpin® 96 Tissue** is designed for the rapid preparation of highly pure genomic DNA from tissue, for example, mouse and rat tails, organ tissue, or animal or bacterial cells. The purified DNA can be used directly as template for PCR, blotting, or any kind of enzymatic reactions.
- This kit provides reagents and consumables for purification of up to 40 µg (average 20 µg) of pure genomic DNA from up to 20 mg tissue samples with an A_{260}/A_{280} ratio between 1.8 and 1.9 and a typical concentration of 100–200 ng/µL.
- From up to two 0.5 cm long mouse tail tip section (age of mice: 4–6 weeks), up to 35 µg of pure genomic DNA can be prepared (typical yields: 15–25 µg).
- **NucleoSpin® 96 Tissue** can be processed by vacuum or in a centrifuge. The kit allow easy automation on common liquid handling instruments.
- The **NucleoSpin® 96 Tissue** kits allow for the purification of multiples of 96 samples. The kits are supplied with accessory plates for highest convenience. The kits are designed for manual or automated use in a centrifuge or for use with a vacuum manifold. The **NucleoSpin® 96 Tissue Core Kit** provides the buffers, Proteinase K and NucleoSpin® Tissue Binding Plate only. Accessory components (e.g., lysis plates, elution plates) are not provided with the core kit but can be individually selected from a variety of suitable accessories (see section 2.4 for further information). This allows highest flexibility for the user.

Kit specifications at a glance

Parameter	NucleoSpin® 96 Tissue
Format	96-well plates
Processing	Manual and automated, vacuum or centrifugation
Sample material	Up to 20 mg tissue, up to 10 ⁶ cultured cells, bacteria
Typical yield	15–25 µg
A ₂₆₀ /A ₂₈₀	1.8–1.9
Elution volume	100–200 µL
Preparation time	60 min/plate (excl. lysis)
Binding capacity	40 µg

2.3 Required hardware

NucleoSpin® 96 Tissue can be processed under vacuum or with centrifugation. Certain hardware for processing is required.

Centrifugation

For centrifugation, a microtiterplate centrifuge is required. This centrifuge must be able to accommodate the NucleoSpin® Tissue Binding Plate stacked on a Round- or Square-well Block and reach accelerations of 5,600–6,000 $x g$ is required (bucket height: 85 mm).

Regarding waste collection, suitable consumables (e.g., MN Square-well Blocks) are necessary and they are not included in the kit. For the most convenient handling, without the need of emptying and reusing the MN Square-well Blocks, we recommend using six MN Square-well Blocks if two 96-well plates are processed at once (see ordering information). Alternatively, it is possible to empty the MN Square-well Blocks after every centrifugation step, reducing the amount of MN Square-well Blocks needed.

Vacuum processing

The **NucleoSpin® 96 Tissue** kit can be used with the NucleoVac 96 Vacuum Manifold (see ordering information). When using **NucleoSpin® 96 Tissue** with less than 96 samples, Self-adhering PE Foil (see ordering information) should be used in order to close and protect non-used wells of the NucleoSpin® Tissue Binding Plate and thus guarantee proper vacuum.

Establish a reliable vacuum source for the NucleoVac 96 Vacuum Manifold. The manifold may be used with a vacuum pump, house vacuum, or water aspirator. We recommend a vacuum of -0.2 to -0.4 bar (reduction of atmospheric pressure). The use of the NucleoVac Vacuum Regulator (see ordering information) is recommended.

Alternatively, adjust the vacuum so that during the purification the sample flows through the column with a rate of 1–2 drops per second. Depending on the amount of sample being used, the vacuum times may need to be increased for complete filtration.

Additionally, a suitable centrifuge for sample preparation steps may be required.

For general consumables and equipment needed, please see section 1.2.

2.4 Accessories supplied for use of the NucleoSpin® 96 Tissue Core Kit

The **NucleoSpin® 96 Tissue Core Kit** provides buffers, Proteinase K, and NucleoSpin® Tissue Binding Plates. Accessory plates (e.g., lysis plates, elution plates) are not provided with the core kit. The reduced kit composition along with a variety of separately available accessories, allow optimal adjustment of the kit to individual user needs. The user can select additional consumables according to his / her requirements for highest flexibility.

For use of **NucleoSpin® 96 Tissue Core Kit**, follow the standard protocols (see section 5.1 and 5.2).

Recommended accessories for use of the **NucleoSpin® 96 Tissue Core Kit** are available from MACHEREY-NAGEL (see ordering information).

Protocol step	Suitable consumables, not supplied with the core kits	Remarks
Lyse samples	4 x Rack of -well Block with Cap Strips per 4 x 96 preps or 4 x Rack of Tube Strips with Cap Strips per 4 x 96 preps	Foe sample lysis

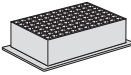
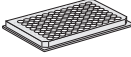
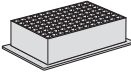
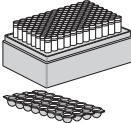
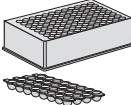
Protocol step	Suitable consumables, not supplied with the core kits	Remarks
Adjust binding conditions	48 x Cap Strips per 4 x 96 preps  4 x MN Square-well Block per 4 x 96 preps 	When using Round-well Block or Tube Strips for lysis, new Cap Strips are required for sealing of wells after adding Buffer BQ1 and ethanol. Recommended for automated processing only
Bind DNA to the membrane	4 x MN Wash Plate per 4 x 96 preps  2 x MN Square-well Block per 4 x 96 preps 	MN Wash Plate minimizes the risk of cross contamination (vacuum processing only). For waste collection during centrifugation (reusable)
Elute DNA	4 x Rack of Tubes Strips with Cap Strips per 4 x 96 preps  or 4 x Round-well Block with Cap Strips per 4 x 96 preps 	

2.5 Automated processing on robotic platforms

NucleoSpin® 96 Tissue can be used fully automated on many common laboratory workstations. For the availability of scripts and general considerations about adapting **NucleoSpin® 96 Tissue** on a certain workstation, please contact MN. Full processing under vacuum enables complete automation without the need for centrifugation steps for drying of the binding membrane or for elution. However, a final elution step by centrifugation is recommended in order to achieve higher concentrated eluted DNA.

The risk of cross-contamination is reduced by optimized vacuum settings during the elution step and by the improved shape of the outlets of the NucleoSpin® Tissue Binding Plate.

Drying of the NucleoSpin® Tissue Binding Plates under vacuum is sufficient because the bottom of the plate is protected by the MN Wash Plate during the washing steps. As a result, it is recommended to integrate the MN Wash Plate into the automated procedure to protect against these wash buffer residues. The MN Frame (see ordering information) can be used to position the disposable MN Wash Plate inside the vacuum chamber. This also reduces the risk of cross-contamination, as common metal adaptors tend to get contaminated by gDNA. Thorough cleaning of the vacuum chamber is recommended after each run to prevent DNA-containing aerosols from forming.

Visit MN online at www.mn-net.com or contact your local MACHEREY-NAGEL distributor for technical support regarding hardware, software, setup instructions, and selection of the protocol. Several application notes of the **NucleoSpin® 96 Tissue** kit on various liquid handling instruments can also be found at www.mn-net.com at Bioanalysis/Literature.

2.6 Elution procedures

It is possible to adjust the elution method and the volume of the elution buffer to the subsequent application of interest. In addition, to the standard method described in the protocols (recovery rate about 70–90 %) there are several modifications possible. Use elution buffer preheated at 70 °C for one of the following procedures:

- **High yield:** Perform two elution steps with the volume indicated in the individual protocol. About 90–100 % of bound nucleic acids can be eluted.
- **High concentration:** Perform one elution step with only 60 % of the volume indicated in the individual protocol. Concentration of DNA will be about 30 % higher than with the standard elution procedure. Maximum yield of bound nucleic acids is about 80 %.
- **High yield and high concentration:** Apply half the volume of elution buffer as indicated in the individual protocol, incubate for 3 min and centrifuge. Apply a second aliquot of elution buffer, incubate and centrifuge again. Thus, about 85–100 % of bound nucleic acids are eluted in the standard elution volume at a high concentration.

- **Convenient elution:** For convenience, elution buffer of ambient temperature may be used. This will result in a slightly lower yield (approximately 20%) compared to elution with heated elution buffer.

Elution may also be performed with Tris-EDTA-buffer (TE) of pH equal or higher than 8. This will increase DNA stability during long term or multi-use storage at 4 °C (or ambient temperature) by inhibiting omnipresent DNases. However, EDTA interferes, depending on the final concentration, with certain downstream applications.

For optimal performance of isolated DNA in downstream applications, we recommend eluting with the supplied elution buffer and storing it, especially long term, at - 20 °C. Several freeze-thaw cycles will not interfere with most downstream applications.

Performance of long-range PCR (e.g., > 10 kb) or the detection limit of trace amount of DNA species, may be reduced after multiple freeze-thaw cycles or prolonged storage of eluted DNA at 4 °C or room temperature. This is due to shearing of DNA or adsorption to surfaces.

Due to the dead volume of the silica membrane, please note that the difference between the dispensed elution buffer volume and the recovered elution buffer volume containing genomic DNA is approximately 20 µL (recovered elution volume = dispensed elution volume - 20 µL).

3 Storage conditions and preparation of working solutions

Attention: Buffer BQ1 and BW contain chaotropic salts. Wear gloves and goggles!

CAUTION: Buffers BQ1 and BW contain guanidine hydrochloride which can form highly reactive compounds when combined with bleach (sodium hypochlorite). DO NOT add bleach or acidic solutions directly to the sample-preparation waste.

Storage conditions:

- All components of the **NucleoSpin® 96 Tissue** kits should be stored at room temperature (18–25 °C) for a maximum of 1 year. Storage at lower temperatures may cause precipitation of salts. If a salt precipitation is observed, incubate the bottle at 30–40 °C for some minutes and mix well until all of the precipitate is redissolved. The performance of the kits is not affected by the salt precipitates.

Before starting any **NucleoSpin® 96 Tissue** protocol, prepare the following:

- Wash Buffer B5:** Add the indicated volume of ethanol (96–100 %) to **Buffer B5 Concentrate** before use. Mark the label of the bottle to indicate that ethanol was added. Store **Wash Buffer B5** at room temperature (18–25 °C) for up to one year.
- Before first use of the kit, add the indicated volume of **Proteinase Buffer PB** to lyophilized **Proteinase K**. Proteinase K solution is stable at - 20 °C for up to 6 months.

NucleoSpin® 96 Tissue			
REF	2 x 96 preps 740741.2	4 x 96 preps 740741.4	24 x 96 preps 740741.24
Wash Buffer B5 (Concentrate)	100 mL Add 400 mL ethanol	2 x 100 mL Add 400 mL ethanol to each bottle	12 x 100 mL Add 400 mL ethanol to each bottle
Proteinase K (lyophilized)	2 x 75 mg Add 2.6 mL Proteinase Buffer PB to each vial	4 x 75 mg Add 2.6 mL Proteinase Buffer PB to each vial	24 x 75 mg Add 2.6 mL Proteinase Buffer PB to each vial

NucleoSpin® 96 Tissue Core Kit

REF	4 x 96 preps 740454.4
Wash Buffer B5 (Concentrate)	2 x 100 mL Add 400 mL ethanol to each bottle
Proteinase K (lyophilized)	4 x 75 mg Add 2.6 mL Proteinase Buffer to each vial

4 Safety instructions – risk and safety phrases

The following components of the **NucleoSpin® 96 Tissue** and **NucleoSpin® 96 Tissue Core** kits contain hazardous contents.

Wear gloves and goggles and follow the safety instructions given in this section.

4.1 Risk and safety phrases

Component	Hazard contents	Hazard symbol	Risk phrases	Safety phrases
<i>Inhalt</i>	<i>Gefahrstoff</i>	<i>Gefahrstoff-symbol</i>	<i>R-Sätze</i>	<i>S-Sätze</i>
BQ1	Guanidine hydrochloride 50–66 % <i>Guanidinhydrochlorid 50–66 %</i>	✘ Xn*	R 22-36/38	S 26-37/39
BW	Guanidine hydrochloride 36–50 % + isopropanol 20–50 % <i>Guanidinhydrochlorid 36–50 % + Isopropanol 20–50 %</i>	✘ Xn*	R 10-22-36	S 16-26-39
Proteinase K	Proteinase K, lyophilized <i>Proteinase K, lyophilisiert</i>	✘ Xn	R 36/37/38-42	S 22-24-26-36/37

Risk phrases

- R 10 Flammable.
Leichtentzündlich
- R 22 Harmful if swallowed.
Gesundheitsschädlich beim Verschlucken.
- R 36 Irritating to the skin.
Reizt die Haut.
- R 36/38 Irritating to eyes and skin.
Reizt die Augen und die Haut.
- R 36/37/38 Irritating to eyes, respiratory system, and skin.
Reizt die Augen, die Atmungsorgane und die Haut.
- R 42 May cause sensitization by inhalation.
Sensibilisierung durch Einatmen möglich.

Safety phrases

- S 16 Keep away from sources of ignition – No smoking!
Von Zündquellen fernhalten – Nicht rauchen!
- S 22 Do not breathe dust.
Staub nicht einatmen.
- S 24 Avoid contact with the skin.
Berührung mit der Haut vermeiden.



* Hazard labeling not necessary if quantity per bottle below 125 g or mL (certificate of exemption according to 67/548/EEC Art. 25, 1999/45/EC Art. 12 and German GefStoffV § 20 (3) and TRGS 200 7.1). For further information see Material Safety Data Sheet.

Safety phrases

- S 26 In case of contact with eyes, rinse immediately with plenty of water and seek medical advice.
Bei Berührung mit den Augen sofort gründlich mit Wasser abspülen und Arzt konsultieren.
- S 36/37 Wear suitable protective clothing and gloves.
Bei der Arbeit geeignete Schutzhandschuhe und Schutzkleidung tragen.
- S 37/39 Wear suitable gloves and eye / face protection.
Bei der Arbeit geeignete Schutzhandschuhe und Schutzbrille / Gesichtsschutz tragen.
- S 39 Wear eye / face protection.
Schutzbrille / Gesichtsschutz tragen.

4.2 GHS classification

Only harmful features need not be labeled with H and P phrases until 125 mL or 125 g. *Mindergefährliche Eigenschaften müssen bis 125 mL oder 125 g nicht mit H- und P-Sätzen gekennzeichnet werden.*

Component	Hazard contents	GHS symbol	Hazard phrases	Precaution phrases
Inhalt	Gefahrstoff	GHS Symbol	H-Sätze	P-Sätze
BQ1	Guanidine hydrochloride 50–66 % <i>Guanidinhydrochlorid 50–66 %</i>	 Warning <i>Achtung</i>	302, 315, 319	280, 301+312, 302+352, 305+351+338, 330, 332+313, 337+313
BW	Guanidine hydrochloride 36–50 % + isopropanol 20–50 % <i>Guanidinhydrochlorid 36–50 % + Isopropanol 20–50 %</i>	 Warning <i>Achtung</i>	226, 302, 319	210, 233, 280, 301+312, 305+351+338, 330, 337+313, 403+235
Proteinase K	Proteinase K, lyophilized <i>Proteinase K, lyophilisiert</i>	 Danger <i>Gefahr</i>	315, 319, 334, 335	261, 280, 302+352, 304+340, 305+351+338, 312, 332+313, 337+313, 342+311, 403+233

Hazard phrases

- H 226 Flammable liquid and vapour.
Flüchtigkeit und Dampf entzündbar.
- H 302 Harmful if swallowed.
Gesundheitsschädlich bei Verschlucken.
- H 315 Causes skin irritation.
Verursacht Hautreizungen.
- H 319 Causes serious eye irritation.
Verursacht schwere Augenreizung.

Hazard phrases

- H 334 May cause allergy or asthma symptoms or breathing difficulties if inhaled.
Kann bei Einatmen Allergie, asthmaartige Symptome oder Atembeschwerden verursachen.
- H 335 May cause respiratory irritation.
Kann die Atemwege reizen.

Precaution phrases

- P 210 Keep away from heat/sparks/open flames/hot surfaces – No smoking.
Von Hitze / Funken / offener Flamme / heißen Oberflächen fernhalten. Nicht rauchen.
- P 233 Keep container tightly closed.
Behälter dicht verschlossen halten.
- P 261 Avoid breathing dust.
Einatmen von Staub vermeiden.
- P 280 Wear protective gloves / eye protection.
Schutzhandschuhe / Augenschutz tragen.
- P 301+312 IF SWALLOWED: Call a POISON CENTER or doctor /physician if you feel unwell.
BEI VERSCHLUCKEN: Bei Unwohlsein GIFTINFORMATIONSZENTRUM oder Arzt anrufen.
- P 302+352 IF ON SKIN: Wash with plenty of soap and water.
BEI KONTAKT MIT DER HAUT: Mit viel Wasser und Seife waschen.
- P 304+340 IF INHALED: Remove victim to fresh air and keep at rest in a position comfortable for breathing.
BEI EINATMEN: An die frische Luft bringen und in einer Position ruhigstellen, die das Atmen erleichtert.
- P 305+351+338 IF IN EYES: Rinse continuously with water for several minutes. Remove contact lenses if present and easy to do – continue rinsing.
BEI KONTAKT MIT DEN AUGEN: Einige Minuten lang behutsam mit Wasser spülen. Vorhandene Kontaktlinsen nach Möglichkeit entfernen. Weiter spülen.
- P 312 Call a POISON CENTER or doctor/physician if you feel unwell.
Bei Unwohlsein GIFTINFORMATIONSZENTRUM oder Arzt anrufen.
- P 330 Rinse mouth.
Mund ausspülen.
- P 332+313 If skin irritation occurs: Get medical advice / attention.
Bei Hautreizung: Ärztlichen Rat einholen / ärztliche Hilfe hinzuziehen.
- P 337+313 Get medical advice / attention.
Bei anhaltender Augenreizung: Ärztlichen Rat einholen / ärztliche Hilfe hinzuziehen.
- P 342+311 If experiencing respiratory symptoms: Call a POISON CENTER or doctor / physician.
Bei Symptomen der Atemwege: Giftinformationszentrum oder Arzt anrufen.
- P 403+233 Store in a well ventilated place. Keep container tightly closed.
Behälter dicht geschlossen an einem gut belüfteten Ort aufbewahren.
- P 403+235 Store in a well ventilated place. Keep cool.
Kühl an einem gut belüfteten Ort aufbewahren.

For further information please see Material Safety Data Sheets (www.mn-net.com).
Weiterführende Informationen finden Sie in den Sicherheitsdatenblättern (www.mn-net.com).

5 Protocols

5.1 NucleoSpin® 96 Tissue – centrifuge processing

- For hardware requirements, refer to section 2.3.
- For detailed information on each step, see page 21.
- For use of the NucleoSpin® 96 Tissue Core Kit (REF 740454.4), refer to section 2.4 regarding recommended accessories.

Before starting the preparation:

- Check if Buffer B5 and Proteinase K were prepared according to section 3.
- Set incubator or oven to 56 °C.
- Preheat Elution Buffer BE to 70 °C.

Protocol-at-a-glance

1	Prepare samples	2 x 0.5 cm mouse tail or up to 20 mg tissue, 10⁶ cultured cells, or bacteria
2	Lyse samples	180 µL T1 25 µL Proteinase K Mix 56 °C, ≥ 6 h
3	Adjust DNA binding conditions	200 µL BQ1 200 µL ethanol (96–100%) Mix
4	Transfer lysates to NucleoSpin® Tissue Binding Plate	
5	Bind DNA to silica membrane of the NucleoSpin® Tissue Binding Plate	5,600 x g, 10 min

6	Wash silica membrane	500 µL BW 5,600 x g, 2 min 700 µL B5 5,600 x g, 4 min
7	Dry silica membrane	70°C, 10 min
8	Elute DNA	100 µL BE (70 °C) 5,600 x g, 2 min

Optional: Repeat elution step once.

Detailed protocol

- For hardware requirements, refer to section 2.3.
- For use of the NucleoSpin® 96 Tissue Core Kit (REF 740454.4), refer to section 2.4 regarding recommended accessories.

Before starting the preparation:

- Check if Buffer B5 and Proteinase K were prepared according to section 3.
 - Set incubator or oven to 56 °C.
 - Preheat Elution Buffer BE to 70 °C.
-

1 Prepare samples

For each preparation, cut up to two 0.5 cm pieces (20 mg) of mouse tail into appropriate lysis tubes or plates. If preparing DNA from rat tails, one 0.5 cm piece is sufficient. Tissue samples should not exceed 20 mg, cultured cells and bacteria should not exceed 10⁶ cells.

2 Lyse samples

Prepare a Proteinase K working solution: For each sample, mix **25 µL Proteinase K** with **180 µL Buffer T1** and vortex. Transfer 200 µL of the resulting solution to each well of the Round-well Block containing the samples. Close the wells with Cap Strips. Mix by vigorous shaking for 10–15 s. Spin briefly (15 s; 1,500 x g) to collect any sample at the bottom of the wells.

The samples must be submerged in the solution. Never prepare the Proteinase K working solution more than 15 min before addition to the samples. Proteinase K tends to self digestion when incubated in Buffer T1 without substrate.

Incubate the Round-well Block containing the samples at **56 °C** for **at least 6 h** (for mammalian cells reduce incubation to 10 min, bacterial cells may require pre-lysis with, e.g., lysozyme) or overnight until the samples are completely lysed. For optimal lysis, mix occasionally during incubation. Place a weight on top of the Round-well Block in order to prevent the Cap Strips from popping off occasionally.

After lysis, set the incubator to 70 °C for the membrane drying step.

Centrifuge the Round-well Block (15 s; 1,500 x g) to collect any condensate from the Cap Strips. Remove Cap Strips.

Residual hair and/or bones in the lysate can be removed by centrifugation (2 min; 5,600–6,000 x g) and transfer of the supernatant to a new Round-well Block (not supplied with the kit).

3 Adjust DNA binding conditions

Add **200 µL Buffer BQ1** and **200 µL 96–100 % ethanol** to each sample. Again, take care not to moisten the rims of the individual wells while dispensing the buffer. Close the individual wells with new Cap Strips (supplied). Mix by vigorous shaking for 10–15 s. Spin briefly (10 s; 1,500 x g) to collect any sample from the Cap Strips.

Ethanol and Buffer BQ1 can be premixed before addition to the samples, if the mixture is to be used during the next 3 months. Never centrifuge at higher g-forces or for longer periods as DNA will precipitate.

Place a NucleoSpin® Tissue Binding Plate on a MN Square-well Block.

If using more than one plate, label the plates for later identification. The use of a second plate placed on a MN Square-well Block avoids the need to balance the centrifuge.

4 Transfer lysates

Remove the first Cap Strip and transfer the lysates resulting from step 2 carefully from the Round-well Block into the wells of the NucleoSpin® Tissue Binding Plate. Continue with the next eight samples. Do not moisten the rims of the individual wells while dispensing the samples – moistened rims may cause cross contamination during centrifugation. After transfer, seal the openings of the plate with Self-adhering PE Foil.

For transfer of the lysate from the Round-well Block to the NucleoSpin® Tissue Binding Plate, we recommend use of an electronic eight-channel pipetting device with extra long tips capable of holding more than 650 µL.

5 Bind DNA to silica membrane

Place the MN Square-well Blocks with NucleoSpin® Tissue Binding Plates onto the centrifuge carriers and insert them into the rotor buckets. Centrifuge at **5,600–6,000 x g** for **10 min**.

Typically, the lysates will have passed through the silica membrane within a few minutes. The centrifugation process can be extended to 20 min, if the lysates have not passed completely.

6 Wash silica membrane

1st wash

Remove the Self-adhering PE Foil and add **500 µL Buffer BW** to each well of the NucleoSpin® Tissue Binding Plate. Seal the plate with a new Self-adhering PE Foil and centrifuge again at **5,600–6,000 x g** for **2 min**.

2nd wash

Remove the Self-adhering PE Foil and add **700 µL Buffer B5** to each well of the NucleoSpin® Tissue Binding Plate. Seal the plate with a new Self-adhering PE Foil and centrifuge again at **5,600–6,000 x g** for **4 min**.

During this step, as much ethanolic Buffer B5 as possible is removed by centrifugation.

7 Dry silica membrane

Remove the Self-adhering PE Foil and place the NucleoSpin® Tissue Binding Plate on an opened Rack of Tube Strips. Place it in an incubator for **10 min** at **70 °C** to evaporate residual ethanol.

Removal of ethanol by evaporation at 70 °C is more effective than prolonged centrifugation.

Note: The ethanol in Buffer B5 may inhibit enzymatic reactions and should be removed completely before eluting DNA.

8 Elute DNA

Dispense **100 µL preheated Buffer BE (70 °C)** to each well of the NucleoSpin® Tissue Binding Plate. Dispense the buffer directly onto the membrane. Incubate at room temperature for **1 min**. Centrifuge at **5,600–6,000 x g** for **2 min**. Repeat elution step once. Remove the NucleoSpin® Tissue Binding Plate from the Rack of Tube Strips by lifting the plate at one side carefully as the Tube Strips may stick to the outlets of the NucleoSpin® Tissue Binding Plate. For alternative elution procedures see section 2.3.

If elution in small volume tubes is desired, place a 96 PCR plate (not supplied) on top of a Round-well Block or a Rack of Tube Strips and elute into the PCR plate.

5.2 NucleoSpin® 96 Tissue – vacuum processing

- For hardware requirements, refer to section 2.3.
- For detailed information regarding the vacuum manifold setup, see page 26.
- For detailed information on each step, see page 27.
- For use of the NucleoSpin® 96 Tissue Core Kit (REF 740454.4), refer to section 2.4 regarding recommended accessories.

Before starting the preparation:

- Check if Buffer B5 and Proteinase K were prepared according to section 3.
- Set incubator or oven to 56 °C.
- Preheat Elution Buffer BE to 70 °C.

Protocol-at-a-glance

1	Prepare samples	2 x 0.5 cm mouse tail or up to 20 mg tissue, 10⁶ cultured cells, or bacteria
2	Lyse samples	180 µL T1 25 µL Proteinase K Mix 56 °C, ≥ 6 h
3	Adjust DNA binding conditions	200 µL BQ1 200 µL ethanol (96–100%) Mix Prepare the NucleoVac 96 Vacuum Manifold
4	Transfer lysates to NucleoSpin® Tissue Binding Plate	
5	Bind DNA to silica membrane of the NucleoSpin® Tissue Binding Plate	-0.2 bar*, 5 min

* Reduction of atmospheric pressure

6	Wash silica membrane	600 µL BW
		900 µL B5
		900 µL B5
		-0.2 bar*,
		5 min each step

Remove MN Wash Plate

7	Dry silica membrane	- 0.6 bar*,
		10 min

8	Elute DNA	100 µL BE (70 °C)
		-0.4 bar*,
		2 min

Optional: Repeat elution step once

* Reduction of atmospheric pressure

Setup of vacuum manifold:

Binding / Washing steps

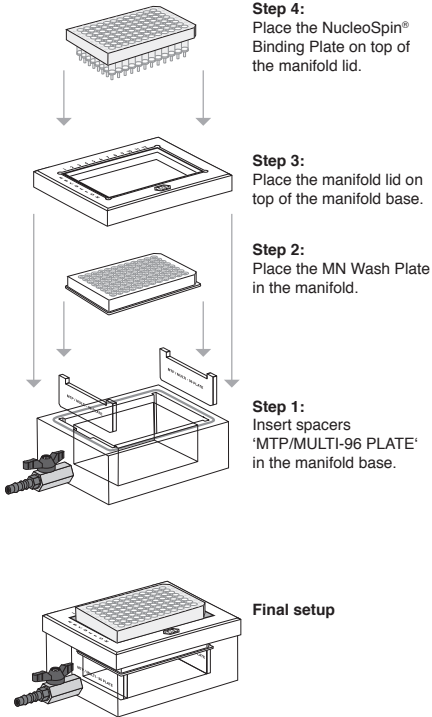

Elution step

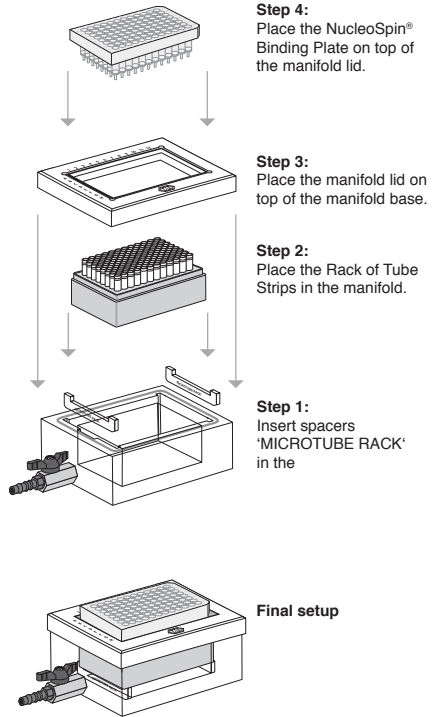

Detailed protocol

- For hardware requirements, refer to section 2.3.
- For detailed information regarding the vacuum manifold setup, see page 26.
- For use of the NucleoSpin® 96 Tissue Core Kit (REF 740454.4), refer to section 2.4 regarding recommended accessories.

Before starting the preparation:

- Check if Buffer B5 and Proteinase K were prepared according to section 3.
 - Set incubator or oven to 56 °C.
 - Preheat Elution Buffer BE to 70 °C.
-

1 Prepare samples

For each preparation, cut up to two 0.5 cm pieces (20 mg) of mouse tail into appropriate lysis tubes or plates. If preparing DNA from rat tails, one 0.5 cm piece is sufficient. Tissue samples should not exceed 20 mg, cultured cells and bacteria should not exceed 10⁶ cells.

2 Lyse samples

Prepare a Proteinase K working solution: For each sample, mix **25 µL Proteinase K** with **180 µL Buffer T1** and vortex. Transfer 200 µL of the resulting solution to each well of the Round-well Block containing the samples. Close the wells with Cap Strips and mix by vigorous shaking for 10–15 s. Spin briefly (15 s; 1,500 x g) to collect any sample at the bottom of the wells.

The samples must be submerged in the solution. Never prepare the Proteinase K working solution more than 15 min before addition to the samples. Proteinase K tends to self digestion when incubated in Buffer T1 without substrate.

Incubate the Round-well Block containing the samples at **56 °C** for **at least 6 h** (for mammalian cells reduce incubation to 10 min, bacterial cells may require pre-lysis with, e.g., lysozyme) or overnight until the samples are completely lysed. For optimal lysis, mix occasionally during incubation. Place a weight on top of the Round-well Block in order to prevent the Cap Strips from popping off occasionally.

Centrifuge the Round-well Block (15 s; 1,500 x g) to collect any condensate from the Cap Strips. Remove Cap Strips.

Residual hair and/or bones in the lysate can be removed by centrifugation (2 min; 5,600–6,000 x g) and transfer of the supernatant to a new Round-well Block (not supplied with the kit).

* Reduction of atmospheric pressure

3 Adjust DNA binding conditions

Add **200 µL Buffer BQ1** and **200 µL 96–100 % ethanol** to each sample. Again, take care not to moisten the rims of the individual wells while dispensing the buffer. Close the individual wells with new Cap Strips (supplied). Mix by vigorous shaking for 10–15 s. Spin briefly (10 s; 1,500 x g) to collect any sample from the Cap Strips.

Ethanol and Buffer BQ1 can be premixed before addition to the samples, if the mixture is to be used up during the next 3 months. Never centrifuge at higher g-forces or for longer periods as DNA will precipitate.

Prepare the NucleoVac 96 Vacuum Manifold:

Place waste tray into vacuum manifold base. Insert spacers labeled “MTP/Multi-96 plate” notched side up and place the MN Wash Plate on them. Close the manifold with the manifold lid and place a NucleoSpin® Tissue Binding Plate on top of the manifold.

4 Transfer lysates

Remove the first Cap Strip and transfer the lysates resulting from step 2 carefully from the Round-well Block into the wells of the NucleoSpin® Tissue Binding Plate. Continue with the next eight samples. Do not moisten the rims of the individual wells while dispensing the samples – moistened rims may cause cross-contamination.

For transfer of the lysate from the Round-well Block to the NucleoSpin® Tissue Binding Plate, we recommend use of an electronic eight-channel pipetting device with extra long tips capable of holding more than 650 µL.

5 Bind DNA to silica membrane

Apply vacuum until all lysates have passed through the wells of the NucleoSpin® Tissue Binding Plate (**-0.2 bar***; **5 min**). Release the vacuum.

* Reduction of atmospheric pressure

6 Wash silica membrane*

1st wash

Add **600 µL Buffer BW** to each well of the NucleoSpin® Tissue Binding Plate. Apply vacuum (**-0.2 bar****; **5 min**) until all buffer has passed through the wells of the NucleoSpin® Tissue Binding Plate. Release the vacuum.

2nd wash

Add **900 µL Buffer B5** to each well of the NucleoSpin® Tissue Binding Plate. Apply vacuum (**-0.2 bar****; **5 min**) until all buffer has passed through the wells of the NucleoSpin® Tissue Binding Plate. Release the vacuum.

3rd wash

Add **900 µL Buffer B5** to each well of the NucleoSpin® Tissue Binding Plate. Apply vacuum (**-0.2 bar****; **5 min**) until all buffer has passed through the wells of the NucleoSpin® Tissue Binding Plate. Release the vacuum.

Remove MN Wash Plate

After the final washing step, close the valve, release the vacuum and remove the NucleoSpin® Tissue Binding Plate. Put it on a clean paper towel to remove residual EtOH-containing wash buffer. Remove manifold lid, MN Wash Plate, and waste container from the vacuum manifold.

7 Dry silica membrane

Insert the NucleoSpin® Tissue Binding Plate into the lid, and close the manifold. Apply maximum vacuum (**at least -0.6 bar****) for **10 min** to dry the membrane completely. This step is necessary to eliminate traces of ethanol.

Note: The ethanol in Buffer B5 inhibits enzymatic reactions and has to be removed completely before eluting DNA.

Finally, release the vacuum.

* Buffer volumes are increased compared to processing under centrifugation to improve washing efficiency under vacuum.

** Reduction of atmospheric pressure

8 Elute DNA

Insert spacers “Microtube rack” into the NucleoVac Vacuum Manifold’s short sides. Place a Rack of Tube Strips onto the spacer. Close the vacuum manifold and place the NucleoSpin® Tissue Binding Plate on top. Dispense **100 µL preheated Buffer BE** onto the membrane. Incubate for **3 min at room temperature**. Apply vacuum for elution (**-0.4 bar***; **2 min**). Release the vacuum and repeat the elution step once. For alternative elution procedures see section 2.3.

Finally, close the Tube Strips with Cap Strips for storage.

Centrifuge Rack of Tube Strips shortly to collect all sample at the bottom of the Tube Strips.

* Reduction of atmospheric pressure

6 Appendix

6.1 Troubleshooting

Problem	Possible cause and suggestions
	<p><i>Incomplete lysis</i></p> <ul style="list-style-type: none">• Sample has not completely been submerged during heat incubation. Cut samples into small pieces. Mix well. Be sure that the samples are fully submerged in Buffer T1 / Proteinase K mixture. Incubate until the samples are completely lysed.• Buffer T1 and Proteinase K have been premixed more than 15 min before addition to the substrate. Proteinase K tends to self digestion under optimal reaction conditions in Buffer T1 without substrate.
No or poor DNA yield	<p><i>Reagents not applied properly</i></p> <ul style="list-style-type: none">• Prepare Buffer B5 and Proteinase K solution according to instructions (see section 3). Add Buffer BQ1 and ethanol to the lysates before loading them to the wells of the NucleoSpin[®] Tissue Binding Plate. <p><i>Suboptimal elution of DNA from the column</i></p> <ul style="list-style-type: none">• Preheat Buffer BE to 70 °C before elution. Apply Buffer BE directly onto the center of the silica membrane.• Elution efficiencies decrease dramatically if elution is done with buffers with pH < 7. Use slightly alkaline elution buffer like Buffer BE (pH 8.5).
RNA contamination	<p><i>RNA in sample</i></p> <ul style="list-style-type: none">• If DNA free of RNA is desired, cool down to room temperature after lysis incubation and add 20 µL of an RNase A solution (20 mg/mL; see ordering information). Incubate for 15 min with moderate shaking.

Problem

Possible cause and suggestions

Poor performance of genomic DNA in enzymatic reactions

Carry-over of ethanol

- After washing with Buffer B5, centrifuge ≥ 4 min at 5,600–6,000 $\times g$ in order to remove ethanolic Buffer B5 completely and evaporate residual ethanol by incubating the NucleoSpin[®] Tissue Binding Plate at 70 °C for 10 min.
- Increase vacuum drying time to 15 min.

Contamination of DNA with inhibitory substances

- Do not elute DNA with TE buffer. EDTA may inhibit enzymatic reactions. Repurify DNA and elute in Buffer BE.
-

Clogged wells

Too much starting material

- Repeat the procedure, using two mouse tail sections of maximally 4–6 mm length. If processing rat tails, one 0.5 cm long tail tip section is sufficient.

Hair or bones left in the lysate after step 2

- Centrifuge the Round-well Block for 3 min at 5,600–6,000 $\times g$. Transfer lysates to a new Round-well Block without disturbing the debris pellet.

Incomplete passage of lysate in step 4

- If no more than 300–500 μL of lysate is remaining in the columns, continue with step 5. Through the addition of Buffer BW the sample is diluted and thus the sample will pass the column more easily.
-

6.2 Ordering information

Product	REF	Pack of
NucleoSpin® 96 Tissue	740741.2	2 x 96 preps
	740741.4	4 x 96 preps
	740741.24	24 x 96 preps
NucleoSpin® 96 Tissue Core Kit	740454.4	4 x 96 preps
NucleoSpin® 8 Tissue	740740	12 x 8 preps
	740740.5	60 x 8 preps
NucleoSpin® 8 Tissue Core Kit	740453.4	48 x 8 preps
Buffer T1	740940.25	25 mL
Buffer BQ1	740923.1	1 l
Buffer B5 Concentrate (for 500 mL Buffer B5)	740921.100	100 mL
Buffer BW	740922.500	500 mL
Proteinase K	740506	100 mg
RNase A (lyophilized)	740505	100 mg
Rack of Tube Strips (1 set consists of 1 rack, 12 strips with 8 tubes each, and 12 Cap Strips)	740477	4 sets
	740477.24	24 sets
Round-well Block (1 set consists of 1 Round-well Block and 12 Cap Strips)	740475	4 sets
	740475.24	24 sets
MN Wash Plate	740479	4
	740479.24	24
Cap Strips	740478	48
	740478.24	288
NucleoVac 96 Vacuum Manifold	740681	1
NucleoVac Vacuum Regulator	740641	1
Self-adhering PE Foil	740676	50

Visit www.mn-net.com for more detailed product information.

6.3 Product use restriction/warranty

NucleoSpin® 96 Tissue (Core Kit) components are intended, developed, designed, and sold FOR RESEARCH PURPOSES ONLY, except, however, any other function of the product being expressly described in original MACHEREY-NAGEL product leaflets.

MACHEREY-NAGEL products are intended for GENERAL LABORATORY USE ONLY! MACHEREY-NAGEL products are suited for QUALIFIED PERSONNEL ONLY! MACHEREY-NAGEL products shall in any event only be used wearing adequate PROTECTIVE CLOTHING. For detailed information please refer to the respective Material Safety Data Sheet of the product! MACHEREY-NAGEL products shall exclusively be used in an ADEQUATE TEST ENVIRONMENT. MACHEREY-NAGEL does not assume any responsibility for damages due to improper application of our products in other fields of application. Application on the human body is STRICTLY FORBIDDEN. The respective user is liable for any and all damages resulting from such application.

DNA/RNA/PROTEIN purification products of MACHEREY-NAGEL are suitable for *IN-VITRO*-USES ONLY!

ONLY MACHEREY-NAGEL products specially labeled as IVD are also suitable for *IN-VITRO*-diagnostic use. Please pay attention to the package of the product. *IN-VITRO*-diagnostic products are expressly marked as IVD on the packaging.

IF THERE IS NO IVD SIGN, THE PRODUCT SHALL NOT BE SUITABLE FOR *IN-VITRO*-DIAGNOSTIC USE!

ALL OTHER PRODUCTS NOT LABELED AS IVD ARE NOT SUITED FOR ANY CLINICAL USE (INCLUDING, BUT NOT LIMITED TO DIAGNOSTIC, THERAPEUTIC AND/OR PROGNOSTIC USE).

No claim or representations is intended for its use to identify any specific organism or for clinical use (included, but not limited to diagnostic, prognostic, therapeutic, or blood banking). It is rather in the responsibility of the user or - in any case of resale of the products - in the responsibility of the reseller to inspect and assure the use of the DNA/RNA/protein purification products of MACHEREY-NAGEL for a well-defined and specific application.

MACHEREY-NAGEL shall only be responsible for the product specifications and the performance range of MN products according to the specifications of in-house quality control, product documentation and marketing material.

This MACHEREY-NAGEL product is shipped with documentation stating specifications and other technical information. MACHEREY-NAGEL warrants to meet the stated specifications. MACHEREY-NAGEL's sole obligation and the customer's sole remedy is limited to replacement of products free of charge in the event products fail to perform as warranted. Supplementary reference is made to the general business terms and conditions of MACHEREY-NAGEL, which are printed on the price list. Please contact us if you wish to get an extra copy.

There is no warranty for and MACHEREY-NAGEL is not liable for damages or defects arising in shipping and handling (transport insurance for customers excluded), or out of accident or improper or abnormal use of this product; defects in products or

components not manufactured by MACHEREY-NAGEL, or damages resulting from such non-MACHEREY-NAGEL components or products.

MACHEREY-NAGEL makes no other warranty of any kind whatsoever, and SPECIFICALLY DISCLAIMS AND EXCLUDES ALL OTHER WARRANTIES OF ANY KIND OR NATURE WHATSOEVER, DIRECTLY OR INDIRECTLY, EXPRESS OR IMPLIED, INCLUDING, WITHOUT LIMITATION, AS TO THE SUITABILITY, REPRODUCTIVITY, DURABILITY, FITNESS FOR A PARTICULAR PURPOSE OR USE, MERCHANTABILITY, CONDITION, OR ANY OTHER MATTER WITH RESPECT TO MACHEREY-NAGEL PRODUCTS.

In no event shall MACHEREY-NAGEL be liable for claims for any other damages, whether direct, indirect, incidental, compensatory, foreseeable, consequential, or special (including but not limited to loss of use, revenue or profit), whether based upon warranty, contract, tort (including negligence) or strict liability arising in connection with the sale or the failure of MACHEREY-NAGEL products to perform in accordance with the stated specifications. This warranty is exclusive and MACHEREY-NAGEL makes no other warranty expressed or implied.

The warranty provided herein and the data, specifications and descriptions of this MACHEREY-NAGEL product appearing in MACHEREY-NAGEL published catalogues and product literature are MACHEREY-NAGEL's sole representations concerning the product and warranty. No other statements or representations, written or oral, by MACHEREY-NAGEL's employees, agent or representatives, except written statements signed by a duly authorized officer of MACHEREY-NAGEL are authorized; they should not be relied upon by the customer and are not a part of the contract of sale or of this warranty.

Product claims are subject to change. Therefore please contact our Technical Service Team for the most up-to-date information on MACHEREY-NAGEL products. You may also contact your local distributor for general scientific information. Applications mentioned in MACHEREY-NAGEL literature are provided for informational purposes only. MACHEREY-NAGEL does not warrant that all applications have been tested in MACHEREY-NAGEL laboratories using MACHEREY-NAGEL products. MACHEREY-NAGEL does not warrant the correctness of any of those applications.

Last updated: 07/2010, Rev. 03

Please contact:
MACHEREY-NAGEL GmbH & Co. KG
Tel.: +49 (0) 24 21 969 270
e-mail: tech-bio@mn-net.com

Trademarks:

NucleoSpin is a registered trademark of MACHEREY-NAGEL GmbH & Co. KG

All used names and denotations can be brands, trademarks, or registered labels of their respective owner – also if they are not special denotation. To mention products and brands is only a kind of information (i.e., it does not offend against trademarks and brands and can not be seen as a kind of recommendation or assessment). Regarding these products or services we can not grant any guarantees regarding selection, efficiency, or operation.