



Product Information

Axio Vert.A1

Simply Get All Information from Your Cells

INTERNET-LINK 

VIDEO/ANIMATION 

Release 1.0



We make it visible.

All Contrasts. All Information. All Flexible.

Axio Vert.A1

Simply Get All Information
from Your Cells

> In Brief

> The Advantages

> The Applications

> The System

> Technology and Details

> Service

Choose from all standard contrasting techniques, including DIC, to investigate your cell cultures. Axio Vert.A1 produces brilliant images to answer your questions.

Axio Vert.A1 is the only system in its class with such a large range of features, compact enough in fact to sit directly beside your incubator. Look into the very essence of your research while keeping your cell culture in its own protected environment.

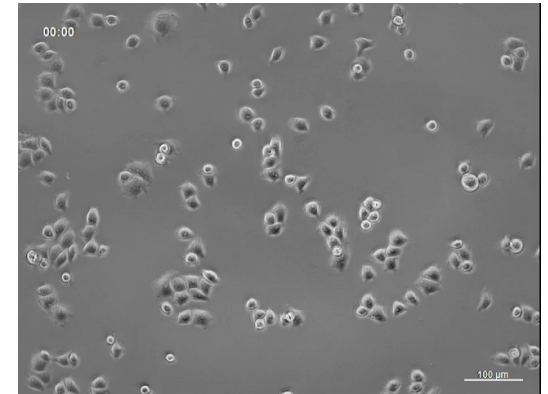

Axio Vert.A1: Simpler. More Intelligent. More Integrated.

Axio Vert.A1

Simply Get All Information from Your Cells

› In Brief

› **The Advantages**

› The Applications

› The System

› Technology and Details

› Service

Using All Standard Contrast Techniques, It's in a Class of its Own

Brightfield, Phase contrast, PlasDIC, VAREL, improved Hoffman Modulation Contrast (iHMC) and Fluorescence contrast – Axio Vert.A1's range reads like an index of contrast techniques. Alone in its class, it also employs Differential Interference Contrast. With DIC you visualize even the finest structures in your cells. And the new IVF contrast system is particularly impressive in IVF labs: without modifying the stand, you can switch freely between iHMC, PlasDIC and DIC as you investigate your samples.

LED Excitation – Gentle on Your Living Samples

You are working with fluorescence-labeled cells or specify transfection rates? With Axio Vert.A1 your samples remain safe in gentle LED light. This microscope brings you tomorrow's standard – today:

- LED excitation has no unwanted UV component, so you will see a significant increase in the survival rate of your cells.
- Profit from an extremely long life time of the light source.
- Homogeneous illumination saves you time and bother on adjustments.
- LED illumination immediately works with full intensity – there is no heating and cooling period required.

Ergonomic Design Makes Your Work Easier

Ease of use is built right into Axio Vert.A1: Whether you are sitting or standing, simply use intermediate pieces to work comfortably in an upright position. The ergo tube lets you tilt the eyepieces as much as you need. You can always view your samples easily. Thanks to ergonomic design of all operating parts, your routine tasks and workflows will be easier – especially when you're in a particular hurry.



Axio Vert.A1

Simply Get All Information
from Your Cells

› In Brief

› The Advantages

› **The Applications**

› The System

› Technology and Details

› Service

Your Insight Into the Technology Behind it

The IVF contrast system unites iHMC, PlasDIC and DIC without modification

The new IVF contrast system is particularly effective in IVF labs: switch at will between iHMC, PlasDIC and DIC without modifying the stand. Axio Vert.A1 unites all three contrast techniques in one condenser and gives you enough room for micromanipulation.

The stable transmitted light arm provides precision you can rely on

Adapt all standard micromanipulators to the stable transmitted light arm of your Axio Vert.A1. Your work will be free of vibration: you regulate your movements under the microscope with extreme precision.

iHMC reveals even finest structures in the cell nucleus

You examine embryos and assess cell nuclei?
iHMC shows nucleus shape and nucleoli brilliantly.

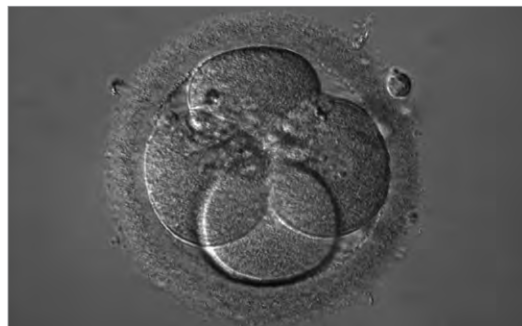

*Embryo: Nucleus with nucleoli visible in right cell
iHMC*

PlasDIC improves your ICSI results

Structures such as the Zona pellucida of oocytes are brought out particularly well by PlasDIC contrast technique. You can judge precisely where to inject, thanks to the strong and brilliant relief effect.



*ICSI: Oocyte with Zona pellucida
PlasDIC*

DIC delivers brilliant images for IMSI

Top marks to DIC with IMSI for producing brilliant images at high magnifications. You can easily assess the shape and vacuole count of sperm cells.

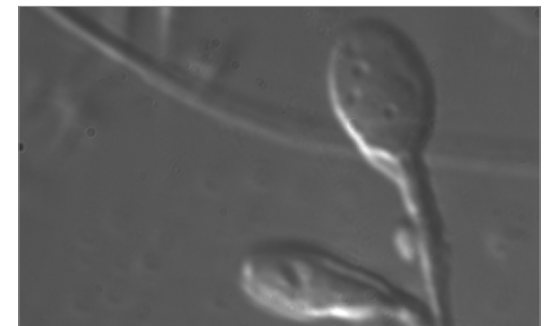

*IMSI: Vacuoles in sperm cells
DIC*

Axio Vert.A1 at Work

Axio Vert.A1

Simply Get All Information
from Your Cells

- › In Brief
- › The Advantages
- › **The Applications**
- › The System
- › Technology and Details
- › Service

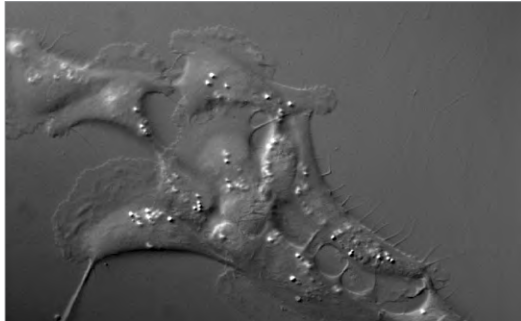

Keratinocytes of epidermis - DIC



HeLa cells - PlasDIC

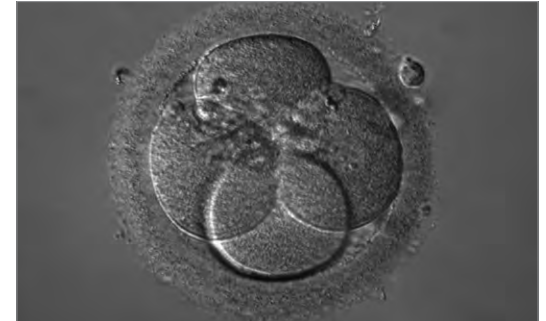

Embryo: nucleus with nucleoli visible in right cell - iHMC

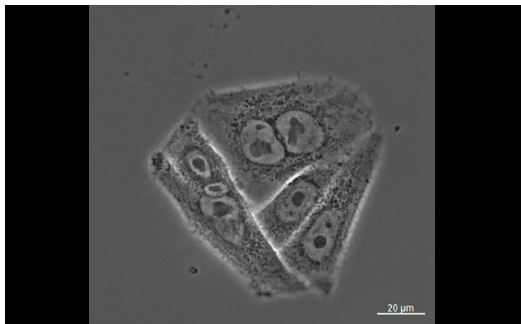

HeLa cells - Phase contrast

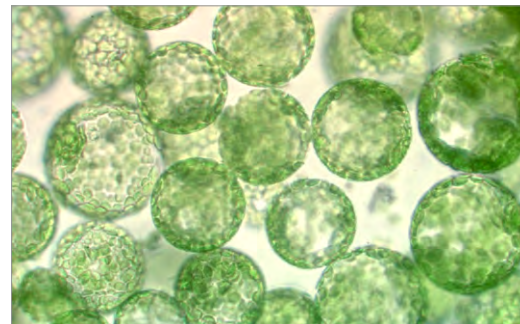

Tobacco, protoplasts - Brightfield

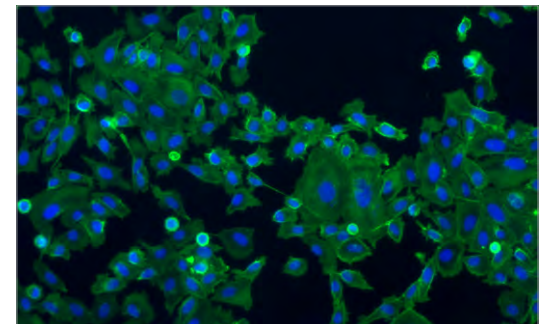

HeLa cells - 2-channel fluorescence

Axio Vert.A1: Your Flexible Choice of Components.

Axio Vert.A1

Simply Get All Information from Your Cells

- › In Brief
- › The Advantages
- › The Applications
- › **The System**
- › Technology and Details
- › Service

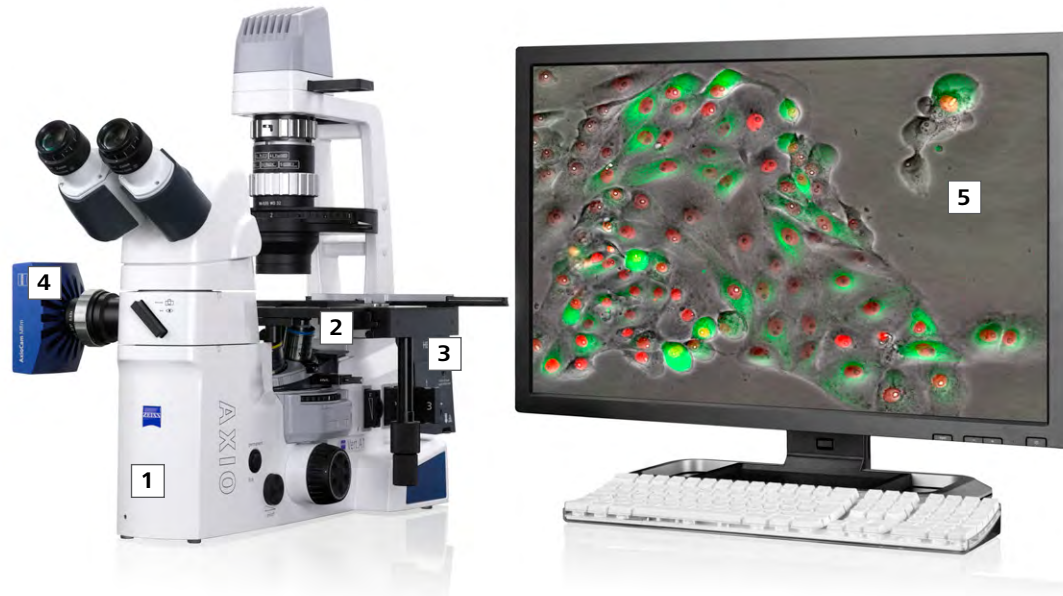

1 Microscope

- Axio Vert.A1, transmitted light
- Axio Vert.A1 FL, transmitted light and fluorescence
- Axio Vert.A1 FL-LED, transmitted light and LED fluorescence

2 Objectives

- A-Plan
- LD A-Plan
- LD Plan-NEOFLUAR

3 Illumination

- Transmitted light: halogen lamp, LED (wavelength 400 to 700 nm, peak at 460 nm)
- Reflected light: HBO 50, HBO 100, HXP 120 C, LED modules (wavelength, nm): 365, 385, 420, 445, 455, 470, 505, 530, 590, 615, 625 or neutral white: 540 - 580 nm

4 Cameras

Recommended cameras:

- AxioCam ERc 5s
- AxioCam ICc 1
- AxioCam ICc 3
- AxioCam ICm 1
- AxioCam MRC
- AxioCam MRm

5 Software

- ZEN lite
- ZEN pro

Axio Vert.A1: System Overview

Axio Vert.A1
Simply Get All Information
from Your Cells

- › In Brief
- › The Advantages
- › The Applications
- › The System
- › Technology and Details
- › Service

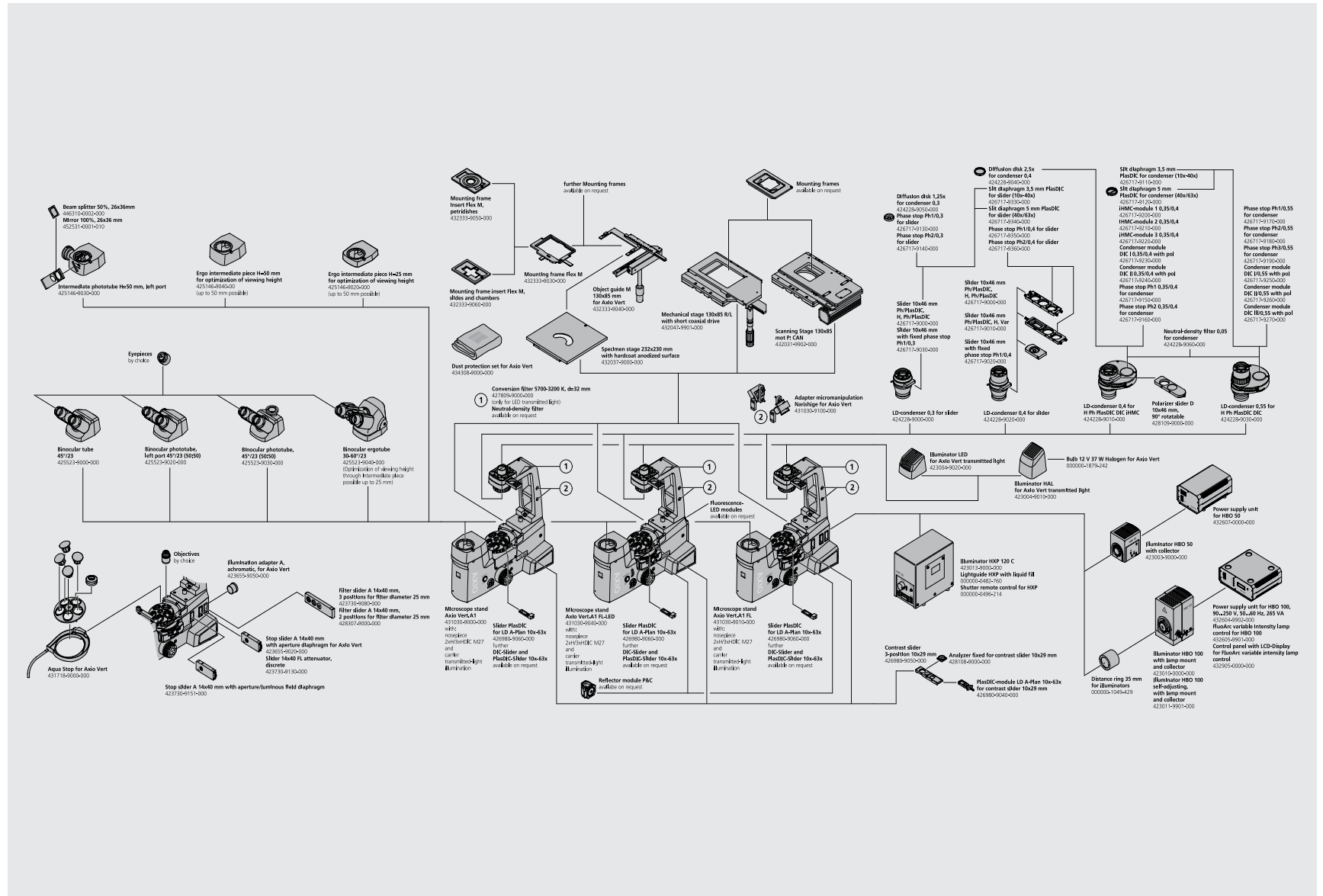

Technical Specifications

Axio Vert.A1

Simply Get All Information from Your Cells

- › In Brief
- › The Advantages
- › The Applications
- › The System
- › **Technology and Details**
- › Service

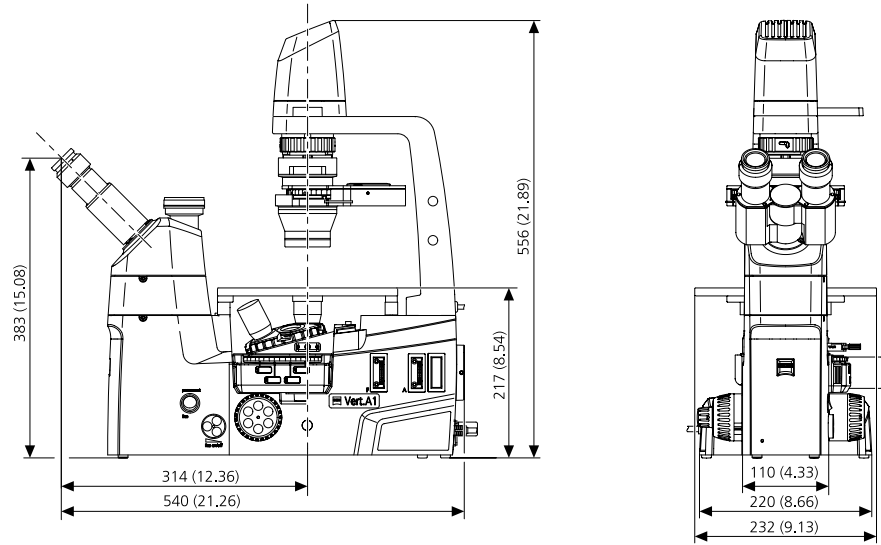

Microscope	Axio Vert.A1	Axio Vert.A1 FL	Axio Vert.A1 FL-LED
Stand	manual inverted stand, transmitted light	manual inverted stand, transmitted light and fluorescence	manual inverted stand, transmitted light and LED fluorescence
Dimensions (W x D x H, including required space for cabling and plugs)	235 x 560 x 560 mm	235 x 560 x 560 mm	235 x 560 x 560 mm
Weight	10.5 kg	11.7 kg	12.3 kg
Eyepieces	Field number 23 (W-PI 10x/23 br foc), diameter: 30 mm		

Technical Specifications

Axio Vert.A1

Simply Get All Information from Your Cells

- › In Brief
- › The Advantages
- › The Applications
- › The System
- › **Technology and Details**
- › Service

Objectives		Axio Vert.A1	Axio Vert.A1 FL	Axio Vert.A1 FL-LED
Nosepiece turret	5x, H DIC M27 man. (2x H, 3x H DIC)	●	●	●
Objectives	A-Plan	○	○	○
	LD A-Plan	○	○	○
	LD Plan-NEOFLUAR	○	○	○
Objective magnification	1.25x-100x	○	○	○
Contrast methods (transmitted light)		Axio Vert.A1	Axio Vert.A1 FL	Axio Vert.A1 FL-LED
Brightfield		●	●	●
Phase contrast		○	○	○
VAREL		○	○	○
PlasDIC		○	○	○
iHMC		○	○	○
DIC		○	○	○
Illumination (transmitted light)		Axio Vert.A1	Axio Vert.A1 FL	Axio Vert.A1 FL-LED
Hal 100 (Halogen)	Output: 37 W, controllability: continuous, ≤ 1,5 to 12V	○	○	○
LED	Output: 3 W, controllability: continuous, ≤ 1,5 to 12V	○	○	○
Fluorescence		Axio Vert.A1	Axio Vert.A1 FL	Axio Vert.A1 FL-LED
HBO 50	Power consumption: max. 90 VA	–	○	–
HBO 100	Power consumption: max. 155 VA	–	○	–
HPX 120 C	Power consumption: max. 210 VA	–	○	–
4-position mount for LED modules	for reflected light fluorescence	–	–	●
4-position reflector turret	for reflected light fluorescence and DIC	–	●	●

● included with stand ○ optional – not possible

Technical Specifications

Axio Vert.A1

Simply Get All Information from Your Cells

- › In Brief
- › The Advantages
- › The Applications
- › The System
- › **Technology and Details**
- › Service

Accessories		Axio Vert.A1	Axio Vert.A1 FL	Axio Vert.A1 FL-LED
Tubes	Binocular tube 45°, 23	○	○	○
	Binocular phototube, left 45°, 23 (50:50)	○	○	○
	Binocular phototube, 45°, 23 (50:50)	○	○	○
	Binocular ergotube, 30°-60°, 23	○	○	○
Tubes, Ergo intermediate pieces	Intermediate phototube, H=50 mm, left port	○	○	○
	Ergo intermediate piece, H=25 mm for optimization of viewing height	○	○	○
	Ergo intermediate piece, H=50 mm for optimization of viewing height	○	○	○
Condensors	LD-condensor 0,3 for slider	○	○	○
	LD-condensor 0,4 for slider	○	○	○
	LD-condensor 0,4 for H Ph PlasDIC DIC iHMC	○	○	○
	LD-condensor 0,55 for H Ph PlasDIC DIC	○	○	○
Stages	Specimen stage with optional object guide M for various mounting frames M	○	○	○
	Mechanical stage 130x85 R/L with short coaxial drive for various mounting frames K	○	○	○
	Gliding stage Z with stage inserts	○	○	○
	Scanning Stage 130x85 mot P; CAN for various mounting frames K	○	○	○
Accessories	Aquastop	○	○	○
	Mounting frames, heatable mounting frames, incubators	○	○	○
	Micromanipulation	○	○	○

● included with stand ○ optional – not possible

Technical Specifications

Axio Vert.A1

Simply Get All Information from Your Cells

- › In Brief
- › The Advantages
- › The Applications
- › The System
- › **Technology and Details**
- › Service

Operational data

Area of use	Closed spaces
Protection class / protection type	I, IP 20
Electrical safety	acc. to DIN EN 61010-1 (IEC 61010-1) allowing for CSA and UL specifications
Overvoltage category	II
Radio interference suppression	acc. to EN 55011 Class B
Interference immunity	acc. to DIN EN 61326-1
Power supply	100 to 240 V AC ± 10 %
Power frequency	50 to 60 Hz
Power consumption internal mains adapter	max. 80 VA

Power supply for HBO 100

Area of use	Closed spaces
Protection class / protection type	I, IP 20
Power supply	100 VAC ... 240 VAC
Power frequency	50/60 Hz
Power consumption with HBO 100	155 VA

Power supply for HBO 50

Area of use	Closed spaces
Protection class / protection type	I, IP 20
Power supply	100 to 240 V AC ± 10 %
Power frequency	50 to 60 Hz
Power consumption HBO 50	max. 90 VA

Power supply for HXP 120 C

Power supply	100 bis 240 V ± 10 %
Power consumption HXP 120 C	max. 210 VA

Technical Specifications

Axio Vert.A1

Simply Get All Information from Your Cells

- › In Brief
- › The Advantages
- › The Applications
- › The System
- › **Technology and Details**
- › Service

Axio Vert.A1 FL-LED

LED-illumination in reflected light with changeable LED modules, wavelengths	365, 385, 420, 445, 455, 470, 505, 530, 590, 615, 625 nm or neutral white (540 - 580 nm)
--	--

LED-classification	LED-risk group 1 acc. DIN EN 62471:2009
--------------------	---

Axio Vert.A1 FL

Wave length	400 to 700 nm, peak at 460 nm
-------------	-------------------------------

LED-classification	LED-risk group 1 acc. DIN EN 62471:2009
--------------------	---

Fuses acc. to IEC 127

Stand Axio Vert.A1	T 3,15 A/H, 5x20 mm
--------------------	---------------------

Power supply for HBO 50	T 1,6 A
-------------------------	---------

Power supply for HBO 100	T 2,0 A/H, 5x20 mm
--------------------------	--------------------

Power supply for HAL 100	T 5,0 A/H, 5x20 mm
--------------------------	--------------------

Count on Service in the True Sense of the Word

Axio Vert.A1

Simply Get All Information from Your Cells

- › In Brief
- › The Advantages
- › The Applications
- › The System
- › Technology and Details
- › **Service**

Your results really matter to us: we want you to get the best you expect from your microscope. Depend on Carl Zeiss for everything you need: technology, software, advice and service. We stay with you long after installation of your microscope on site. Carl Zeiss specialists will continue to maintain your systems, repair them, supply spare parts and much more. Just call us: we are always here for you.

Total Protection with Your Carl Zeiss Service Contract

It's the safe and practical way to preserve the efficiency of your microscope system. Our service contract protects you against expensive downtime.

Preventive Maintenance Plus Optimizes Performance

Our specialists will maintain and tune your system at regular intervals. You get valuable advice and comprehensive answers to any and all questions. We will also keep you right up to date on developments in your field of application.

The Standard Contract Also Includes Repairs and Support

In addition to all the services of Preventive Maintenance Plus, the standard contract covers all repair and support services. The only costs you will ever pay are for replacement components. Another important aspect of the standard contract is installation of software updates – your system will always be running the latest software version.

The Premium Contract Covers Spare Parts Too

Opt for the premium contract and you will have all services of the standard contract, plus free spare parts. This means you can predict your running costs precisely – and budget for them.

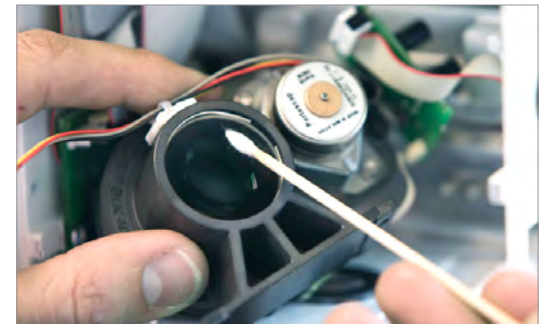

We are here for you:

www.zeiss.com/microservice

The moment technology provides
you with a result the first time.

This is the moment we work for.

Axio Vert.A1

Simply Get All Information
from Your Cells

- › In Brief
- › The Advantages
- › The Applications
- › The System
- › Technology and Details
- › Service



// CONFIDENCE
MADE BY CARL ZEISS

Axio Vert.A1

Simply Get All Information
from Your Cells

- › In Brief
- › The Advantages
- › The Applications
- › The System
- › Technology and Details
- › Service



facebook.com/zeissmicroscopy



twitter.com/zeiss_micro



youtube.com/zeissmicroscopy



Carl Zeiss Microscopy GmbH

07745 Jena, Germany
BioSciences
microscopy@zeiss.com
www.zeiss.com/axiovert



We make it visible.